

INNOVATIVE



VERSATILE



POWERFUL



Ditec DAB305

EN

Automation for swing doors
The solution to meet all your needs

Ditec DAB305

Stylish, quiet and fully comprehensive

The Ditec DAB305 electromechanical automatic swing door operator is capable of moving **any type of interior or exterior door simply and quietly**. The extensive choice of solutions offered makes the DAB305 the **ideal swing door operator for any application**. The solution features 3 operating units, all with additional, pre-assembled configuration cards, to guarantee the best performance:

- **DAB305PS**: operating unit with ESE and ESA configuration cards (installed), articulated arm (DAB805PSA3), 20 mm shaft extension (DAB805SE22) and 345 mm telescopic extension (DAB805TFL)



- **DAB305PL**: operating unit with ESE and ESA configuration cards (installed), sliding arm (DAB805PLA3), 20 mm shaft extension (DAB805PAE) and adapter for installation heights lower than 20 mm (DAB805LA)



- **DAB305**: operating unit with ESE and ESA configuration cards (installed); 20 mm shaft extension (DAB805PAE) and adapter for installation heights lower than 20 mm (DAB805LA) for sliding arms; 20 mm shaft extension (DAB805SE22) and 345 mm telescopic extension (DAB805TFL) for articulated arms



DAB905ESA



DAB905ESE



DAB805SE22



DAB805LA



DAB805PAE



DAB805TFL



A MODERN, FUNCTIONAL DESIGN

With total height of just 70 mm, the DAB305 automatic operator has sleek, modern looks that are perfectly suited to the design needs of contemporary buildings.

The design of the Ditec DAB305 has also been conceived to guarantee fully comprehensive installation: its compact size is particularly suitable for slimmer profiles and smaller areas.



BARRIER-FREE ENTRANCE

The automatic functioning of Ditec operators guarantees streamlined access, as each door can be easily opened.

Ditec door operating units include a LOW ENERGY mode, to meet the stringent safety requirements of the public sector. The Ditec DAB305 can be activated from a pushbutton, a radar motion sensor or with PUSH&GO and Servo-Assistance functions.

Ditec DAB305 | Superior performance

MAXIMUM POWER

An innovative and powerful gear motor capable of guaranteeing an excellent performance in terms of maximum weight and door wing widths:

Maximum capacity		Door wing width	
450 kg	with articulated arm DAB805PSA3	500 – 1600 mm	with articulated arm (1400 mm for fire doors)
370 Kg	with sliding arm DAB805PLA3 or DAB805PLA4	750 – 1400 mm	with sliding arm (same width for fire doors)

UNIVERSAL OPERATION

An extensive range of arms ensures different performance levels in terms of application, weight and size of the wings, guaranteeing the best installation solution, every time



DAB805PSA3: articulated movement arm (also for fire doors)

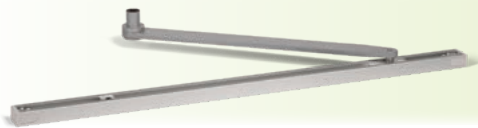

DAB805PLA3: pull arm with 400 mm stroke (also for fire doors) and 690 mm sliding track



DAB805PLA4: pull arm with 600 mm stroke and 890 mm sliding track

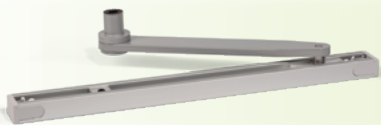

DAB805PLA5: pull arm with 220 mm stroke and 380 mm sliding track

SUPERBLY SMOOTH

DAB305 is a powerful, precise operating mechanism, also for two swing doors, thanks to a perfect dynamic control. There are multiple possibilities for movement management:

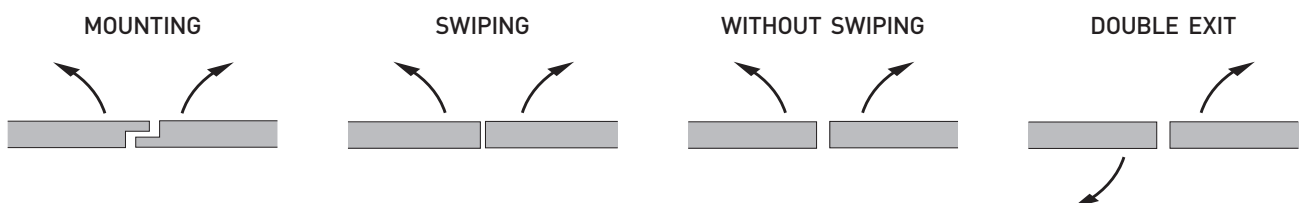

For swing doors, the operators are connected in parallel, using the DAB905SYN sync cable. A fire door can also be put in place, conforming to standards, using the DAB805COU coordination unit, to guarantee the correct mechanical closing sequence.

Ditec DAB305 | Safety above all

Modern buildings demand **flexible solutions** capable of catering for any need, especially with regards to safety. Ditec offers a range of smart intelligent systems that meet these needs: the Ditec DAB305 is the new-generation operating unit for swing doors, with particular attention paid to **escape routes and fire and smoke prevention measures**.

DOUBLE ACTION, FOR ANY EMERGENCY



A special kit (DAB805DAR or DAB805DAL) enables manual door opening **in both directions** (push/pull: DOUBLE ACTION) with automatic reset. Ideal for use on escape routes, **conforms to EN 16005** requirements on manual opening along escape routes.

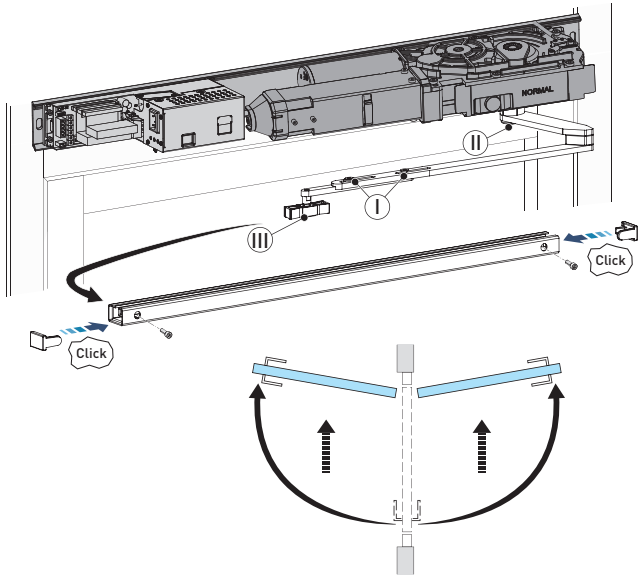

INVERSE: ALWAYS SAFE



Each Ditec DAB305 operating unit enables the doors **to open without power**, regardless of the type of arm.

Thanks to the INVERSE mode, the energy needed for opening is mechanically accumulated by a spring during the motor closing cycle. As **smoke and/or heat have to be extracted**, the DAB305 opens safely and reliably, even when there is no electricity.

READY FOR EVERY TYPE OF USE



The Ditec DAB305 is **approved for use on smoke and fire doors** (EN1634-1; DIN 18263-4). Thanks to the ESE configuration already included in each operating unit, the transit route is immediately closed in the event of fire. Closing is mechanical, with spring action. DAB905FIK fire prevention solutions also feature **a fire door kit** with smoke detector, reset & indication device and closing brake kit.



Ditec DAB305

Quality, right down to the very last detail

Innovative



The Ditec DAB305 has been conceived to offer **state-of-the art** technology matched with contemporary design:

- **Elegantly stylish but also extraordinarily practical**, with a total height of just 70 mm
- Superior **energy efficiency** with a switching power supply unit offering a wide range of operating voltages
- **Quick to configure**, with a smart start-up mode **with self-acquisition function**
- 21 sets of pre-configured parameters, **for simple, error-proof configuration**



Versatile



The Ditec DAB305 is an electromechanical door operator catering for the needs of every possible application in **complete safety**:

- PUSH&GO, LOW ENERGY and Servo-Assistance
- Specific PULL arm for small doors
- PULL arm for push operation
- DOUBLE ACTION version, allowing for **manual door opening in both directions for use in escape routes**
- INVERSE function with spring-action door opening for **smoke evacuation or fail-safe aperture in case of loss of power**
- Usable for **fire doors**

Powerful



Compact and quiet but with a potent gear motor delivering **class-beating performance** even with heavy doors:

- Maximum capacity up to **450 kg** (solution with articulated arm for 950 mm wide door wings)
- **Automatic closing force** adjustment in accordance with wind pressure
- Closing force **EN 4 -7** for version with articulated arm and **EN 4 - 6** for version with sliding arm (in accordance with the standards **DIN 18263-4** and **EN 1154, 1155** and **1158**)
- Maximum door wing width **1600 mm** (1400 mm in case of fire doors)

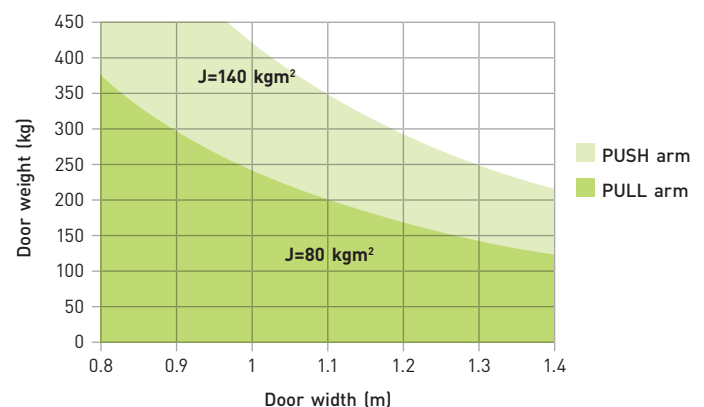

Ditec DAB305

A fully-comprehensive product

COM400MHB

Mechanical switch program selector



DAB905SYN

Sync cable, L = 3000 mm



COM400MKB

Mechanical key program selector



DAB805C37

Cover, L = 3700 mm



DAB905BAT3

Battery kit



DAB805COU

Mechanical coordination device



DAB805DAR

Double acting kit, right-side opening



DAB805DAL

Double acting kit, left-side opening



DAB905FIK

Kit for systems with fire doors, containing an ORS142W smoke detector, reset & indication device, closing brake kit and tripolar connection cable harness



DLR02-DLR1L-DLR1R

Left and right-side safety sensor (DLR02), for left-side installation (DLR1L) or right-side installation (DLR1R)



DAB905SD1

ORS142 smoke detector



DAB805SSD1

DAB905SD1 support for smoke detector



REM90

Single ray presence sensor in box L = 900 mm



REM110

Single ray presence sensor in box L = 1100 mm



DAB805ROD

Rod kit for mechanical coordination device (3, 650 mm bars)



DAB805FP20

Finger protection, for outdoor use, L = 2015 mm (EN 16005)



Ditec DAB305 | A certified product

Fully conforming to EU directives and standards



- 2006/42/EC - Machinery Directive
- 2014/30/EU - Electromagnetic Compatibility Directive
- EN 16005 - Power operated pedestrian doorsets
- EN & IEC 60335 - 1 and 2 - Safety of electrical appliances
- EN 60950 - Information technology equipment
- EN 61000 - 6 - Electromagnetic compatibility
- EN ISO 13849 - 1 - Safety of machinery
- DIN 18263 - 4 - Fire and smoke protection
- EN 1634 - 1 - Fire resistance
- EN 1158 - Door coordinator devices
- 2011/65/EU - RoHS Restriction of Hazardous Substances



Main components

Sturdy and functional

Pre-drilled base plate in steel



Stylish and practical

Anodised cover, 70 mm high

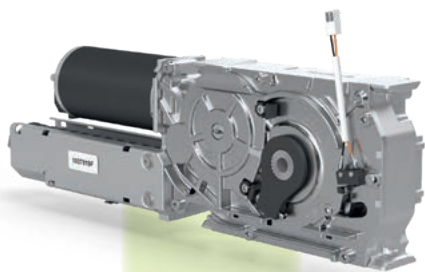
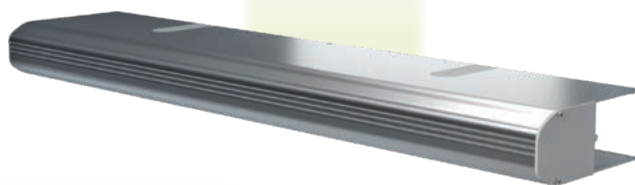

Motor unit

Powerful and quiet



Electronic panel with auto-learning and pre-configured parameters

Wide range of settings



Battery kit

Safe

Technical specifications

	DAB305
Description	Automation for swing doors
Opening	motor and/or spring opening and closing
Product dimensions (H x W x L)	70 x 175 x 840 mm
Product weight	15 Kg
Maximum capacity (see diagram on use)	450 kg with the articulated arm 370 kg with the sliding arm
Power supply	100-240 V AC +10/-15%, 50/60 Hz
Power consumption (max.)	max 300W
Auxiliary power	700 mA - 24 V DC
Electro-mechanical locking	12 V DC max 1200 mA or 24 V DC max 600 mA
Maximum wing width	articulated arm 500 - 1600 mm (1400 mm for fire doors) sliding arm 750 - 1400 mm (same width for fire doors)
Door wing opening angle	articulated arm 110° sliding arm 110°
Opening time (0 - 80°)	2.5 - 12 s
Closing time (90° - 10°)	4 - 12 s
Hold open time	0 - 30 s
Operating temperature	-20°C / +45°C
Protection rating	IP20

Operating functions

ESE configuration card	■ (electrically operated lock, selector, fire function)
ESA configuration card	■ (sensors, door status, alarms)
Integrated base selector	■
Automatic mode	■
Door-closer mode	■
Low Energy mode	■
Power Assist mode	■
PUSH&GO mode	■
INVERSE mode	■
DOUBLE ACTION mode	■ (optional)
Battery operation	■ (optional)
Synchronised double-wing management	■ (optional)
Fire rated	■ DIN 18263-4, EN 1158, EN16005
Fire door kit	■ (optional)
Coordination kit	■ (optional)

System type

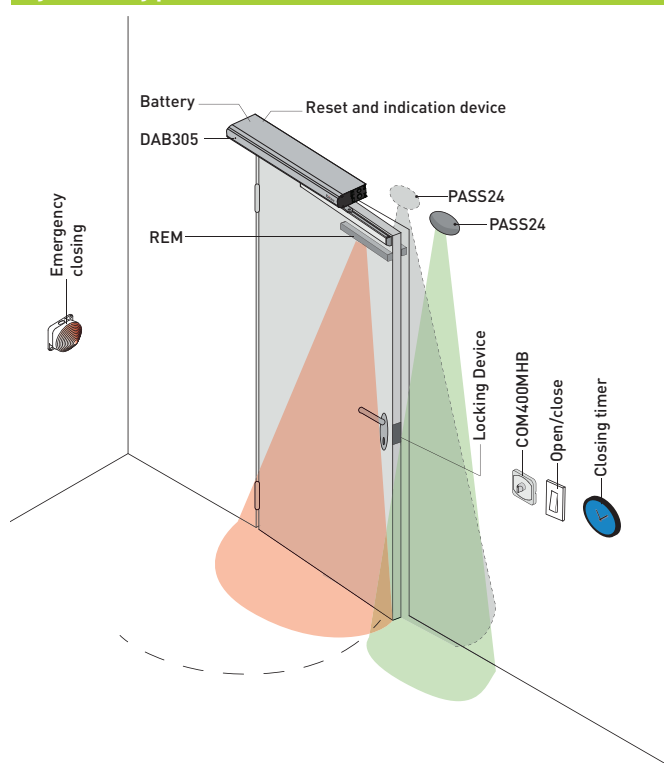

Cert. No. 0957/6

Entrematic Italy S.p.A.

Largo U. Boccioni, 1 • 21040 Origgio (VA) • Italy

Tel +39 02 963911 • Fax: +39 02 9650314

ditec@entrematic.com

www.ditecentrematic.com

Code P236B - 10/2020

Ditec DAB305

Automation for swing doors

gdp milano 193665